





AX1800 Dual-Band Wi-Fi 6 Router

Explore the New Era of Wi-Fi



Archer AX20

 Faster AX Wi-Fi
Speed up to 1.8 Gbps[†]

 Connect More, Stay Fast
OFDMA Supported

 Powerful
Processing

 USB
Sharing

Highlights

802.11 AX Wi-Fi 6 Connects More Devices

The Archer AX20, based on the next generation 802.11ax Wi-Fi technology, takes your Wi-Fi to the next level while being backwards compatible with 802.11a/b/g/n/ac Wi-Fi standards.

AX

4-Streams AX Wi-Fi

Enjoy a faster and more stable network for streaming and gaming with lower latency and speeds up to 1.8 Gbps using newer mobile devices.[†]



4× Increased Capacity

Add devices without dragging performance. OFDMA greatly improves network performance by 4 times to connect more devices simultaneously.[§]



Smooth Streaming

OFDMA allows clients to transmit both on uplink and downlink sharing one band at one time, which cuts the latency and jittering.[‡]



Save Clients' Power

Target Wake Time helps mobile devices, especially IoT devices, consume less power during data transmission cycles to prolong battery life.[‡]

Boosted Coverage

Four high-gain antennas and Beamforming transmit Wi-Fi signals to every corner of your home and concentrate signals strength towards connected devices. Wi-Fi 6 adjusts the bandwidth of sub-channels, making signals clearer and ensuring larger coverage.[†]



Highlights

VPN Client Supported

With VPN client support, AX20 allows specified devices in your home network to access remote VPN servers without needing to install VPN software on every device. AX20 can also run both the VPN and ordinary internet connections at the same time, delivering security and flexibility.

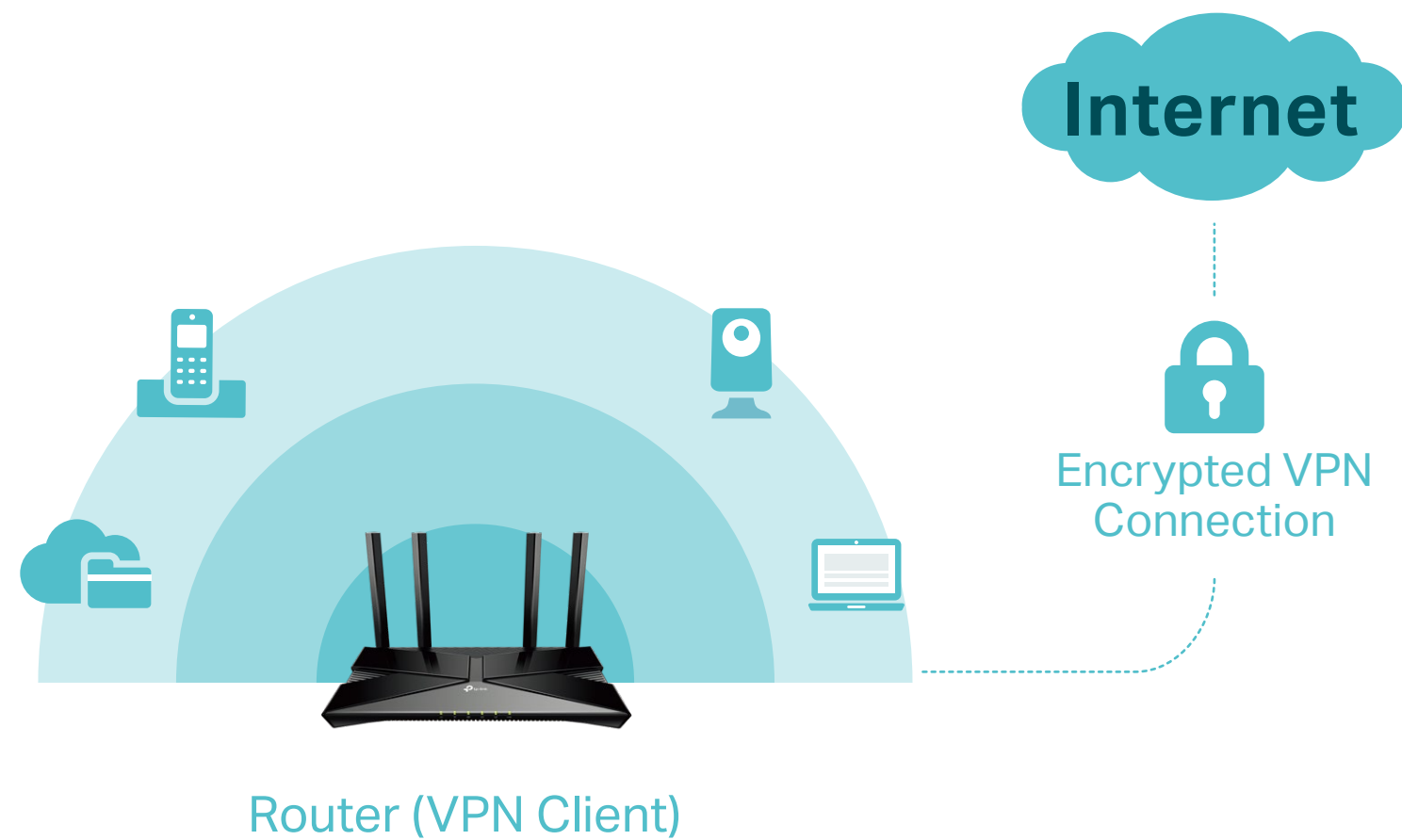

Gigabit Internet Access

Take full advantage of your broadband with speed up to 1 Gbps with a Gigabit WAN port. Plug your PCs, smart TVs and game consoles into one of the four Gigabit LAN ports for fast and reliable wired connections.[^]

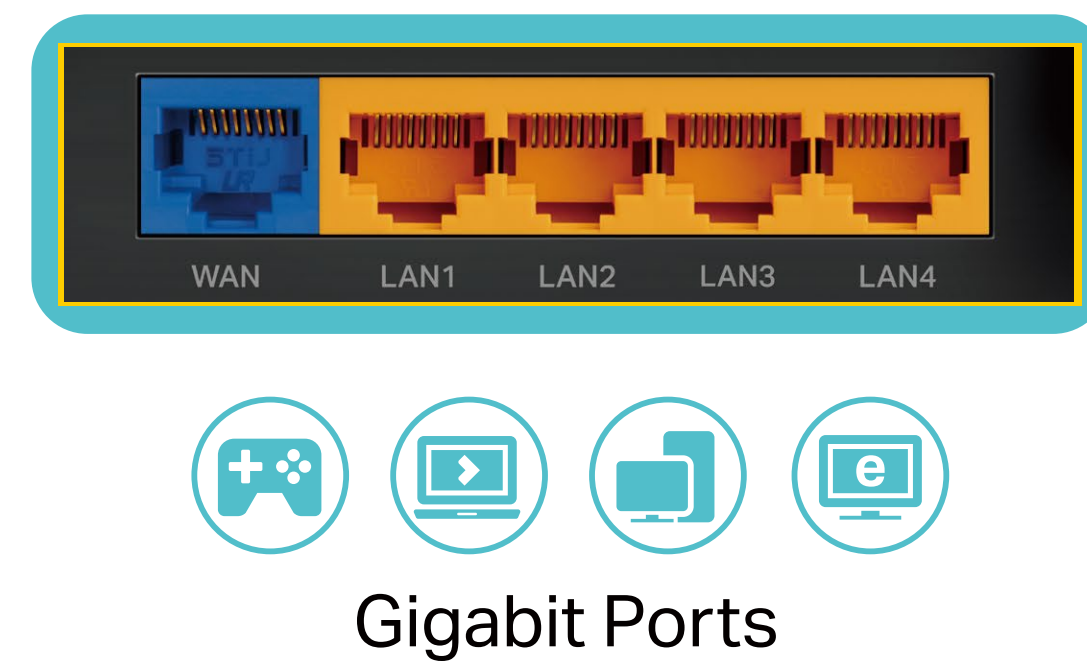

Features



Speed

- **Wi-Fi 6 Technology** – The new era of Wi-Fi with speeds up to 1.8 Gbps[†]
- **OFDMA** – Provides 4× greater capacity for more simultaneous connections.[§]
- **Next-Gen Wireless Speed** – 574 Mbps on 2.4 GHz (802.11ax) + 1201 Mbps on 5 GHz (802.11ax)[†]
- **High-Performance CPU** – Helps accelerate wired and wireless transmission simultaneously to keep your connections fast and uninterrupted.

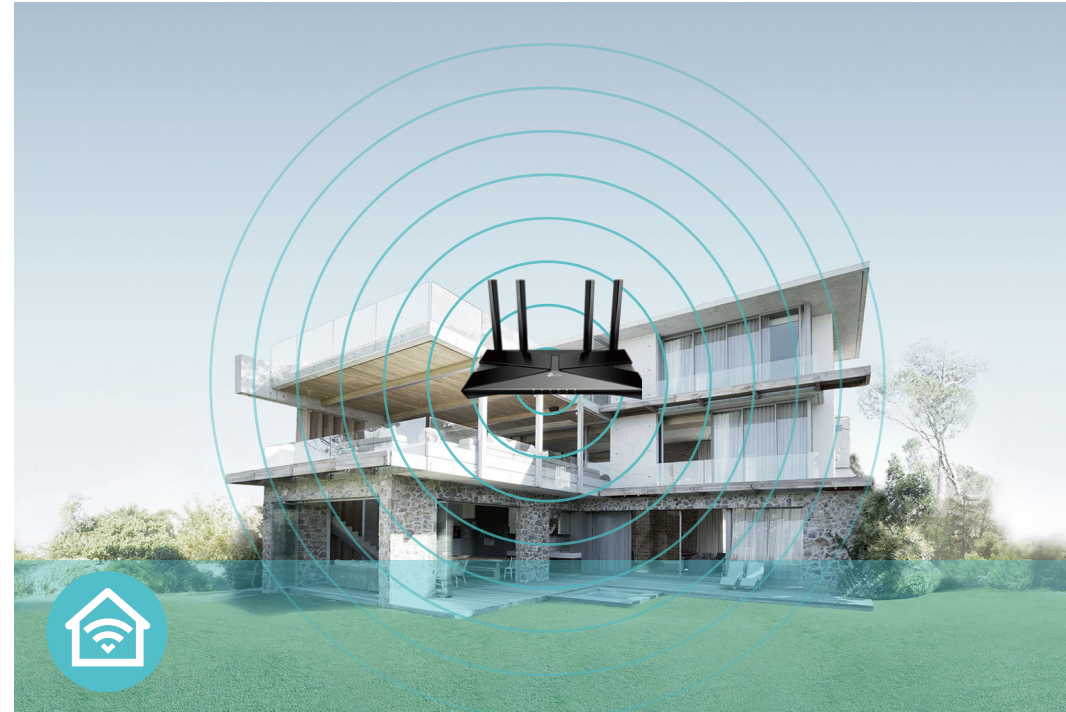

Wi-Fi Range

- **Ultimate Range Wi-Fi** – Four high-gain external antennas deliver a Wi-Fi signal to every corner of your home, making all of your connections more efficient and stable.
- **Beamforming Technology** – Concentrates Wi-Fi signals towards individual devices to ensure stronger connections



Reliability

- **Secure VPN Access** – Connects to a private network with a safe and secure OpenVPN, PPTP, and L2TP VPN connection
- **Airtime Fairness** – Balances bandwidth of connected devices to improve overall throughput and efficiency
- **Smart Connect** – Intelligently switches each device's connection to the optimum available Wi-Fi band

Features

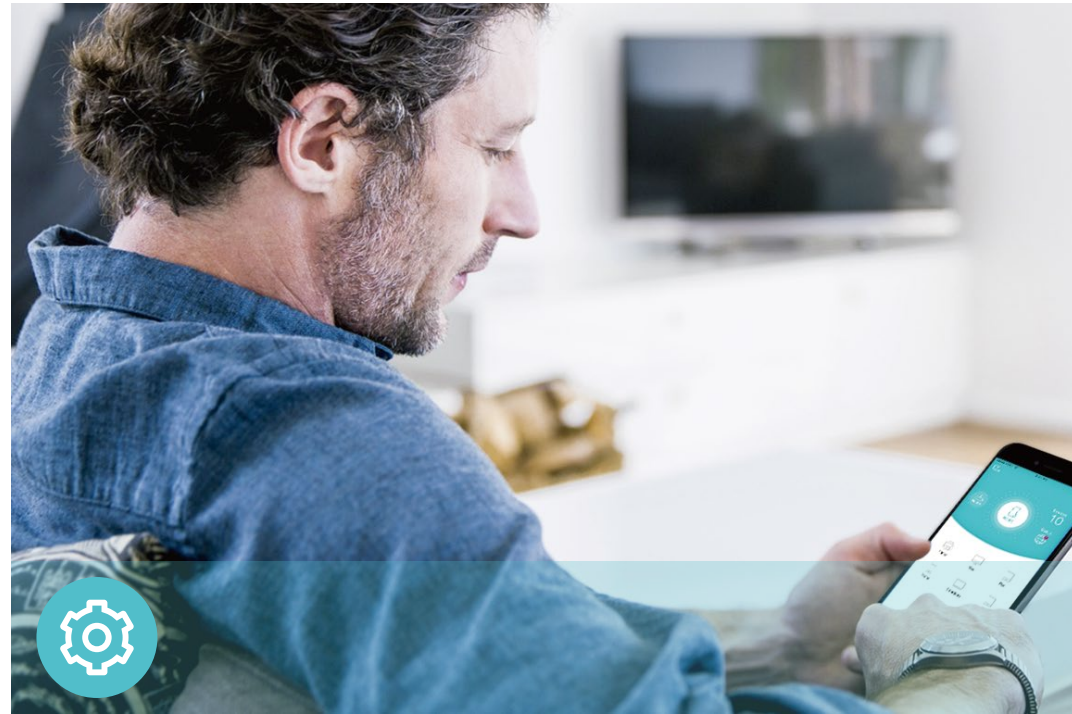

Ease of Use

- Intuitive Web UI – Ensures quick and simple installation without hassle
- Fast Encryption – One-touch WPA wireless security encryption with the WPS button
- Easy On/Off – Turn on/off wireless radio using the Wi-Fi button.
- Power On/Off – Conveniently power on or off your router as required
- Hassle-free Management with Tether App – Network management is made easy with the TP-Link Tether app, available on any Android and iOS device



Security

- Parental Controls – Manage when and how connected devices can access the internet
- Guest Network – Provides separate access for guests to secure the home network
- Access Control – Establishes a whitelist or blacklist to allow or restrict certain devices to access the internet
- Encryptions for Secure Network – WPA/WPA2-Personal, WPA2/WPA3-Personal, WPA/WPA2-Enterprise encryptions provide active protection against security threats

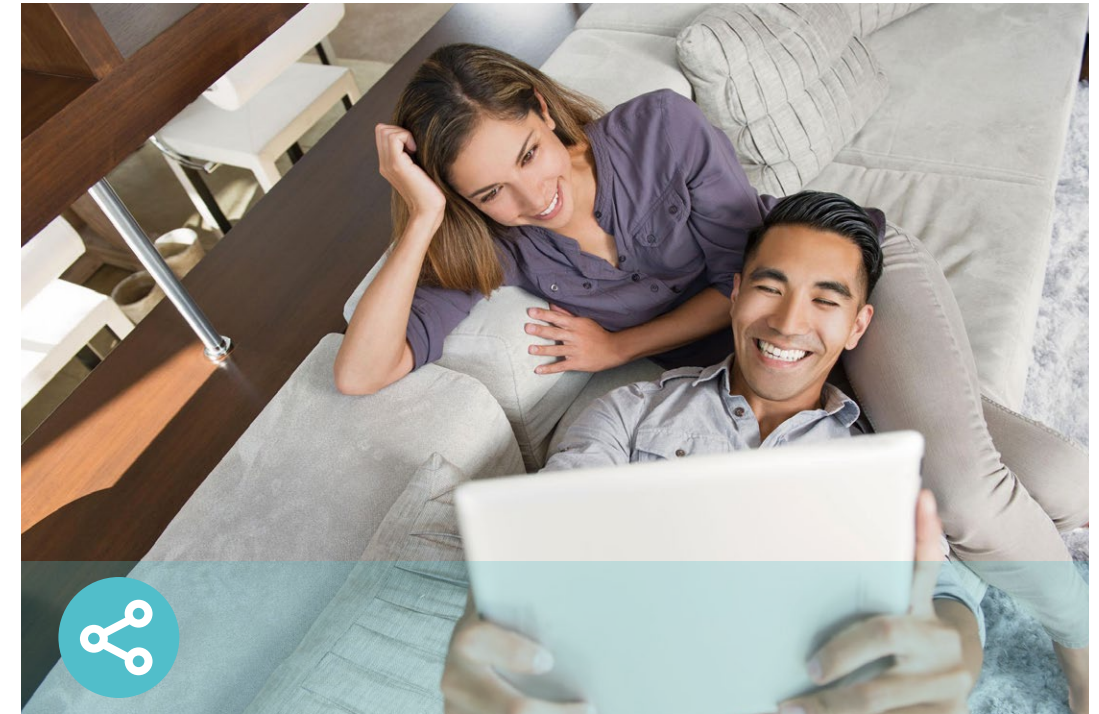

Easy Sharing

- USB Port – Connects external storage devices to rapidly share files, photos, and videos
- Built-in Media Server – Allows you to play music, watch videos and view photos from any device on your network

Specifications

Hardware

- Ethernet Ports: One Gigabit WAN Port, four Gigabit LAN Ports
- USB Port: One USB 2.0 Port
- Buttons: WPS/Wi-Fi Button, Power On/Off Button, Reset Button
- Antennas: Four External Antennas
- External Power Supply: 12V/2.0A
- Dimensions (W x D x H): 10.2 × 5.3 × 1.5 in (260.2 × 135.0 × 38.6 mm)

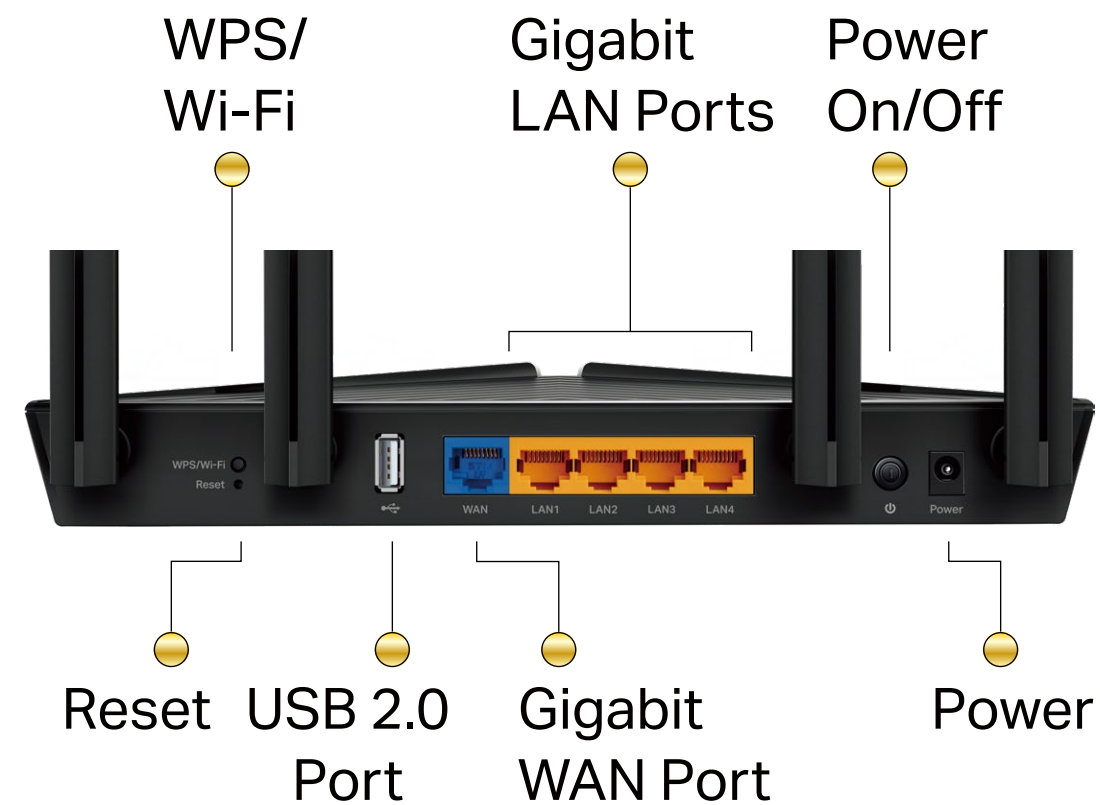

Wireless

- **Wireless**: 1201 Mbps (5 GHz, 11ax) + 574 Mbps (2.4 GHz, 11ax), compatible with 11a/b/g/n/ac Wi-Fi standards
- **Frequency**: 2.4 GHz and 5 GHz
- **Transmit Power**:
FCC:<30dBm(2.4 GHz & 5.15 GHz~5.825 GHz)
- **Reception Sensitivity**:
5 GHz:
11a 6Mbps:-97dBm, 11a 54Mbps:-79dBm
11ac VHT20_MCS0:-96dBm, 11ac VHT20_MCS11:-66dBm
11ac VHT40_MCS0:-94dBm, 11ac VHT40_MCS11:-63dBm
11ac VHT80_MCS0:-91dBm, 11ac VHT80_MCS11:-60dBm
11ax HE20_MCS0:-95dBm, 11ax HE20_MCS11:-63dBm
11ax HE40_MCS0:-92dBm, 11ax HE40_MCS11:-60dBm
11ax HE80_MCS0:-89dBm, 11ax HE80_MCS11:-58dBm
2.4 GHz:
11g 6Mbps:-97dBm
11n HT20_MCS0:-97dBm, 11n HT20_MCS7:-78dBm
11n HT40_MCS0:-95dBm, 11n HT40_MCS7:-75dBm
11ac VHT20_MCS0:-96dBm, 11ac VHT20_MCS11:-67dBm
11ac VHT40_MCS0:-94dBm, 11ac VHT40_MCS11:-64dBm
11ax HE20_MCS0:-96dBm, 11ax HE20_MCS11:-64dBm
11ax HE40_MCS0:-93dBm, 11ax HE40_MCS11:-61dBm
- **Wireless Function**: Enable/Disable Wireless Radio, WMM, Wireless Statistics
- **Wireless Security**: WPA/WPA2-Personal, WPA2/WPA3-Personal, WPA/WPA2-Enterprise

Specifications

Software

- Quality of Service: Device Prioritisation
- WAN Type: Dynamic IP/Static IP/PPPoE/PPTP(Dual Access)/L2TP(Dual Access)
- Management: Access Control, Local Management, Remote Management
- DHCP: Server, DHCP Client List, Address Reservation
- NAT Forwarding: Port Forwarding, Port Triggering, UPnP, DMZ
- Dynamic DNS: DynDns, NO-IP, TP-Link
- Access Control: Parental Controls, Local Management Control, Host List, White List, Black List
- Firewall Security: SPI Firewall, IP and MAC Address Binding
- Protocols: IPv4, IPv6
- USB Sharing: Supports Samba(Storage)/FTP Server/Media Server
- Guest Network: 2.4 GHz Guest Network, 5 GHz Guest Network
- VPN Server: OpenVPN, PPTP VPN, L2TP VPN
- VPN Client: OpenVPN, PPTP VPN, L2TP VPN

Others

- Certification:
FCC, CE, RoHS
- System Requirements:
Microsoft Windows 98SE/NT/2000/XP/Vista™/7/8/8.1/10, MAC OS, NetWare, UNIX or Linux

Internet Explorer 11, Firefox 12.0, Chrome 20.0, Safari 4.0, or other Java-enabled browser

Cable or DSL Modem

Subscription with an internet service provider (for internet access)
- Environment:
Operating Temperature: 0°C~40°C (32°F ~104°F)
Storage Temperature: -40°C~70°C (-40°F ~158°F)
Operating Humidity: 10%~90% non-condensing
Storage Humidity: 5%~90% non-condensing
- Package Contents
Wireless Router Archer AX20

Power Adapter

RJ45 Ethernet Cable

Quick Installation Guide



For more information, please visit

<http://www.tp-link.com/products/details/Archer-AX20.html>

or scan the QR code left

Attention: This device may only be used indoors in all EU member states and EFTA countries.

This device complies with part 15 of the FCC Rules. Operation is subject to the following two conditions: (1) This device may not cause harmful interference, and (2) this device must accept any interference received, including interference that may cause undesired operation. Specifications are subject to change without notice.

[†]Maximum wireless signal rates are the physical rates derived from IEEE Standard 802.11 specifications. Actual wireless data throughput, wireless coverage and number of connected devices are not guaranteed and will vary as a result of network conditions, client limitations, and environmental factors, including building materials, obstacles, volume and density of traffic, and client location.

[‡]Use of 802.11ax (Wi-Fi 6), and features including OFDMA, 1024-QAM and BSS Color requires clients to also support those features.

[§]4x average throughput refers to 4x increase in median throughput under dense environment (i.e. 8+ Wi-Fi 6 devices connected with combined speeds not higher than ISP offers) compared to a 2x2 11ac wave 2 router.

[¶]1,000 Mbps internet speeds require compatible service plans and equipment.

©2022 TP-Link